

Installation and Operation

Table of Contents

Introduction	2	Installation	13
Qualified Persons	2	Installing the Cutout Mounting	13
Read this Instruction Sheet	2	Installing a VacuFuse II Interrupter into the	
Retain this Instruction Sheet	2	Cutout Mounting	14
Proper Application.....	2	Closing the VacuFuse II Interrupter into the	
Operating Considerations.....	3	Cutout Mounting	15
Warranty.....	3	Operation	16
Application Note.....	4	If the VacuFuse II Self-Resetting Interrupter Has	
Safety Information	5	Dropped Open	16
Understanding Safety-Alert Messages	5	If Maintenance Is to Be Performed on the	
Following Safety Instructions.....	5	Transformer	17
Replacement Instructions and Labels	5	Opening and Closing the VacuFuse II Interrupter ...	18
Location of Safety Labels	6	Removing the VacuFuse II Interrupter from the	
Safety Precautions	7	Cutout Mounting	20
Shipping and Handling	8	Operation Using Loadbuster®—The S&C	
Inspection	8	Loadbreak Tool.....	21
Packing	8	Troubleshooting	26
Handling.....	8	Unable to Close a VacuFuse II Interrupter into	
Storage.....	8	its Mounting	26
Returning.....	8	In Mounting With Contacts Open	26
Before Starting	9	Vacuum Interrupter Cannot Be Closed	26
VacuFuse II Interrupter Parts	9		
Understanding the Closing Sequence	10		
Understanding the LED Indicators and			
POSITION Indicator.....	11		



Introduction

Qualified Persons

WARNING

Only qualified persons who are knowledgeable in the installation, operation, and maintenance of distribution fusing equipment, along with all associated hazards, may install, operate, and maintain the equipment covered by this publication. A qualified person is someone who is trained and competent in:

- The skills and techniques necessary to distinguish exposed live parts from nonlive parts of electrical equipment
- The skills and techniques necessary to determine the proper approach distances corresponding to the voltages to which the qualified person will be exposed
- The proper use of special precautionary techniques, personal protective equipment, insulating and shielding materials, and insulated tools for working on or near exposed energized parts of electrical equipment

These instructions are intended ONLY for such qualified persons. They are not intended to be a substitute for adequate training and experience in safety procedures for this type of equipment.

Read this Instruction Sheet

NOTICE

Thoroughly and carefully read this instruction sheet before installing or operating a VacuFuse II Self-Resetting Interrupter. Become familiar with the Safety Information on pages 5 through 6 and Safety Precautions on page 7. The latest version of this publication is available online in PDF format at sandc.com/en/support/product-literature/.

Retain this Instruction Sheet

This instruction sheet is a permanent part of the VacuFuse II Self-Resetting Interrupter. Designate a location where users can easily retrieve and refer to this publication.

Proper Application

WARNING

The VacuFuse II Self-Resetting Interrupter is only intended for the protection of distribution transformers. The application must be within the ratings furnished for the equipment. Ratings for the VacuFuse II Self-Resetting Interrupter are listed in the ratings table in Specification Bulletin 466-31. They are also etched on the body of the interrupter.

Operating Considerations

For Fault-Testing VacuFuse II Self-Resetting Interrupters: The VacuFuse II Self-Resetting Interrupter is factory-set with a TCC curve, an open interval between the initial trip (TCC0) and the first test (TCC1) of 45 ± 10 seconds, as well as a sequence reset time (between 30 seconds and 15 minutes.)

The sequence of operation is as follows: The interrupter will open once in response to its TCC curve and will have an open interval lasting 45 ± 10 seconds. Then, it will close, and its TCC curve will again become active.

If the fault is still on the line, the VacuFuse II Self-Resetting Interrupter will lock open and drop out. If fault current is not still on the line, the **Sequence Reset Time** timer will begin timing. If another fault occurs during this time, the VacuFuse II Self-Resetting Interrupter will lock open and drop out. If this timer expires without the VacuFuse II interrupter detecting fault current, the VacuFuse II interrupter will reset to TCC0. Unless it has been specifically requested at the time of order, TCC0 is the same curve as TCC1.

For Non-Fault-Testing VacuFuse II Interrupters: Non-fault-testing VacuFuse II interrupters are factory-set with a single TCC curve. The sequence of operation is as follows: The interrupter will open once in response to its TCC curve and lock open. When sufficient energy has built up in the device (45 ± 10 seconds), the unit will drop out.

Warranty

The warranty and/or obligations described in S&C's Price Sheet 150 "Standard Conditions of Sale—Immediate Purchasers in the United States" (or Price Sheet 153, "Standard Conditions of Sale—Immediate Purchasers Outside the United States"), plus any special warranty provisions, as set forth in the applicable product-line specification bulletin, are exclusive. The remedies provided in the former for breach of these warranties shall constitute the immediate purchaser's or end user's exclusive remedy and a fulfillment of the seller's entire liability. In no event shall the seller's liability to the immediate purchaser or end user exceed the price of the specific product that gives rise to the immediate purchaser's or end user's claim. All other warranties, whether express or implied or arising by operation of law, course of dealing, usage of trade or otherwise, are excluded. The only warranties are those stated in Price Sheet 150 (or Price Sheet 153), and THERE ARE NO EXPRESS OR IMPLIED WARRANTIES OF MERCHANTABILITY OR FITNESS FOR A PARTICULAR PURPOSE. ANY EXPRESS WARRANTY OR OTHER OBLIGATION PROVIDED IN PRICE SHEET 150 (OR PRICE SHEET 153) IS GRANTED ONLY TO THE IMMEDIATE PURCHASER AND END USER, AS DEFINED THEREIN. OTHER THAN AN END USER, NO REMOTE PURCHASER MAY RELY ON ANY AFFIRMATION OF FACT OR PROMISE THAT RELATES TO THE GOODS DESCRIBED HEREIN, ANY DESCRIPTION THAT RELATES TO THE GOODS, OR ANY REMEDIAL PROMISE INCLUDED IN PRICE SHEET 150 (OR PRICE SHEET 153).

Application Note

VacuFuse II Self-Resetting Interrupters are expressly designed for protecting solidly grounded single-phase overhead distribution transformers in single-phase applications with primary voltages of 7.2 kV to 15.5 kV. These voltages correspond to the line-to-neutral voltages of single-phase transformers on systems rated 12.47 kV to 27.0 kV.

9-kV rated VacuFuse II interrupters (base catalog numbers 4x1xxx and 4x2xxx) are only designed for the applications listed above on systems rated 12.47 to 15.5 kV.

⚠ WARNING

VacuFuse II interrupters have only been developed for use in present-production (“-R10” or “-R11”) S&C-provided cutout mountings. See the example in Figure 1. An example of an earlier-production S&C cutout mounting is shown in Figure 2.

S&C only recommends using VacuFuse II interrupters with S&C cutout mountings.

Applying a VacuFuse II interrupter in an improper mounting may result in improper operation, leading to arcing, faults, equipment damage, serious injury, or death.



Figure 1. A present-production (“-R10” or “-R11”) S&C-provided Type XS Fuse Cutout mounting.

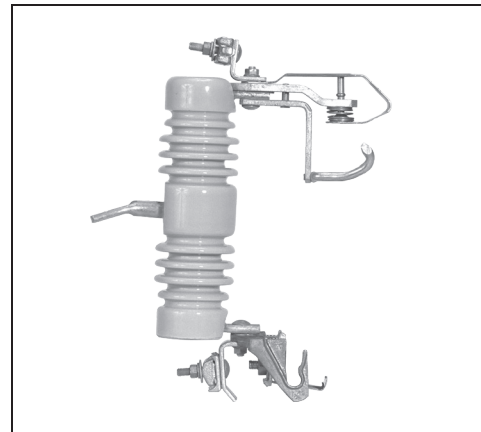

Figure 2. An earlier-production (“-R9”) S&C Type XS Fuse Cutout mounting. “-R8” and earlier versions have a similar upper contact.

Understanding Safety-Alert Messages

Several types of safety-alert messages may appear throughout this instruction sheet and on labels and tags attached to the VacuFuse II Self-Resetting Interrupter. Become familiar with these messages and the importance of these signal words:

⚠ DANGER
“DANGER” identifies the most serious and immediate hazards that will likely result in serious personal injury or death if instructions, including recommended precautions, are not followed.

⚠ WARNING
“WARNING” identifies hazards or unsafe practices that can result in serious personal injury or death if instructions, including recommended precautions, are not followed.

⚠ CAUTION
“CAUTION” identifies hazards or unsafe practices that can result in minor personal injury if instructions, including recommended precautions, are not followed.

NOTICE
“NOTICE” identifies important procedures or requirements that can result in product or property damage if instructions are not followed.

Following Safety Instructions

If any portion of this instruction sheet is unclear and assistance is needed, contact the nearest S&C Sales Office or S&C Authorized Distributor. Their telephone numbers are listed on S&C’s website sandc.com, or call the S&C Global Support and Monitoring Center at 1-888-762-1100.

NOTICE	
Read this instruction sheet thoroughly and carefully before installing the VacuFuse II Self-Resetting Interrupter.	

Replacement Instructions and Labels

If additional copies of this instruction sheet are required, contact the nearest S&C Sales Office, S&C Authorized Distributor, S&C Headquarters, or S&C Electric Canada Ltd.

It is important that any missing, damaged, or faded labels on the equipment be replaced immediately. Replacement labels are available by contacting the nearest S&C Sales Office, S&C Authorized Distributor, S&C Headquarters, or S&C Electric Canada Ltd.

Safety Information

Location of Safety Labels



Reorder Information for Safety Labels

Location	Safety Alert Message	Description	Part Number
A	⚠ WARNING	A VacuFuse® II Self-Resetting Interrupter must be dropped out from the cutout mounting to be considered OPEN and de-energized.	G-9842
	⚠ DANGER	Device may be energized from either side...	
B	TCC CURVE	(Label displaying the VacuFuse II interrupter's protection curve)	●

- Contact the nearest S&C Sales Office.

⚠ DANGER



The VacuFuse II Self-Resetting Interrupter operates at high voltage. Failure to observe the precautions below will result in serious personal injury or death.

Some of these precautions may differ from your company's operating procedures and rules. Where a discrepancy exists, follow your company's operating procedures and rules.

1. **QUALIFIED PERSONS.** Access to the VacuFuse II Self-Resetting Interrupter must be restricted only to qualified persons. See the "Qualified Persons" section on page 2.
2. **SAFETY PROCEDURES.** Always follow safe operating procedures and rules.
3. **PERSONAL PROTECTIVE EQUIPMENT.** Always use suitable protective equipment, such as rubber gloves, rubber mats, hard hats, safety glasses, and flash clothing, in accordance with safe operating procedures and rules.
4. **SAFETY LABELS.** Do not remove or obscure any of the "DANGER," "WARNING," "CAUTION," or "NOTICE" labels and tags. Remove tags ONLY if instructed to do so.
5. **ENERGIZED COMPONENTS.** Always consider all parts live until de-energized, tested, and grounded.
6. **OPERATING TOOLS.** To close a VacuFuse II Self-Resetting Interrupter, use a conventional insulated hotstick or S&C Universal Pole and Pole Extension fitted with a Talon™ Handling Tool or distribution prong. An extendostick also can be used after proper training and practice. When energized or installed near energized lines, contacts should be considered live until tested and grounded. The VacuFuse II interrupter can be operated using Loadbuster®— The S&C Loadbreak Tool attached to a conventional insulated hotstick or S&C Universal Pole.
7. **MAINTAINING PROPER CLEARANCE.** Always maintain proper clearance from energized components.
8. **DO NOT DISASSEMBLE** the VacuFuse II Self-Resetting Interrupter. There are no customer-serviceable parts inside the VacuFuse II interrupter, and disassembling the VacuFuse II interrupter will void the warranty.
9. **VACUUM INTERRUPTER POSITION.** Always confirm the **Open/Closed** position of the VacuFuse II Self-Resetting Interrupter's vacuum interrupter by observing the POSITION indicator on the bottom of the unit. The manual operating lever will not move when the position of the vacuum interrupter changes.

Shipping and Handling

Inspection

Examine the shipment for external evidence of damage as soon after receipt as possible, preferably before removal from the carrier's conveyance. Check the bill of lading to make sure the listed shipping skids, crates, and containers are present. If there is visible loss or damage:

1. Notify the delivering carrier immediately.
2. Ask for a carrier inspection.
3. Note the condition of shipment on all copies of the delivery receipt.
4. File a claim with the carrier.

If concealed damage is discovered:

1. Notify the delivering carrier within 15 days of receipt of shipment.
2. Ask for a carrier inspection.
3. File a claim with the carrier.

Also, notify S&C Electric Company in all instances of loss and/or damage.

Packing

A complete VacuFuse II Self-Resetting Interrupter consists of the following components:

- The VacuFuse II Self-Resetting Interrupter
- A present-production ("R10") Type XS Cutout Mounting and miscellaneous mounting hardware for securing the cutout mounting to the pole, if specified

Handling

NOTICE

DO NOT DROP the VacuFuse II Self-Resetting Interrupter or subject any of its parts to undue stress during installation. Only remove a VacuFuse II Self-Resetting Interrupter from the carton immediately before installation.

Storage

Single-pack VacuFuse II Self-Resetting Interrupters are not suitable for outdoor storage because water can pool and damage the VacuFuse II interrupters. After receipt, single-pack VacuFuse II Interrupters should be stored indoors in their shipping packaging. Storing single-pack VacuFuse II interrupters outdoors in the shipping packing will void the warranty.

Multi-pack VacuFuse II Self-Resetting Interrupters are shipped on pallets banded together, and are packaged correctly for outdoor storage.

Returning

When returning the VacuFuse II Self-Resetting Interrupter for any reason, place the VacuFuse II interrupter in the original shipping carton to prevent damage during shipment. If additional shipping cartons are required, contact the nearest S&C Sales Office, S&C Authorized Distributor, or S&C Headquarters.

VacuFuse II Interrupter Parts

Become familiar with the parts of the VacuFuse II Self-Resetting Interrupter. See Figure 3.

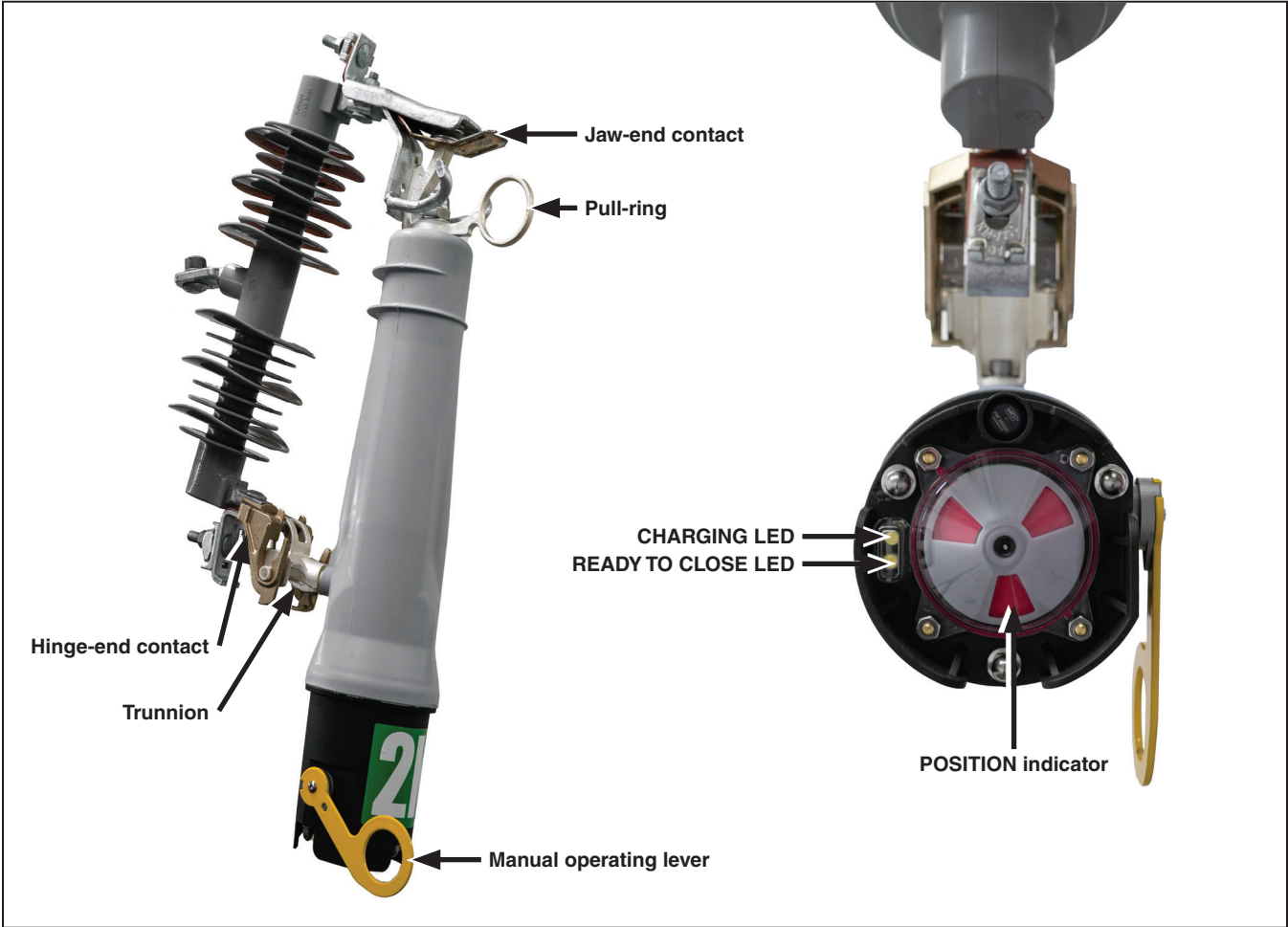

Figure 3. An overview of the VacuFuse II Self-Resetting Interrupter.

Understanding the Closing Sequence

Note: The VacuFuse II Self-Resetting Interrupter is shipped from the factory with the vacuum interrupter in the **Open** position.

After closing the VacuFuse II Self-Resetting Interrupter into the cutout mounting, the CHARGING LED will blink at a 1-second interval as long as there is sufficient voltage present at the cutout mounting and the vacuum interrupter is open.

The READY TO CLOSE LED will steadily illuminate when the VacuFuse II Self-Resetting Interrupter has harvested enough energy to close the vacuum interrupter and when the manual operating lever is in the **Down** position.

The VacuFuse II Self-Resetting Interrupter requires 45 ± 10 seconds to harvest enough energy to close the vacuum interrupter.

There are two ways to close the vacuum interrupter:

Option 1 – Automatic Delayed Close

Place the manual operating lever into the **Up** position prior to closing the unit into the cutout mounting, or less than 35 seconds after the CHARGING LED has begun blinking. When closed into the cutout mounting in this state, the CHARGING LED will blink at a 1-second interval if there is sufficient voltage present at the cutout mounting and the vacuum interrupter is open. The unit will automatically close the vacuum interrupter after 45 ± 10 seconds.

Option 2 – Manual Close

Place the manual operating lever into the **Down** position prior to closing the unit into the cutout mounting, or less than 35 seconds after the CHARGING LED has begun blinking.

Wait until the READY TO CLOSE LED is solidly lit. At that time, the unit can be closed manually by moving the manual operating lever to the **Up** position. Three seconds after the lever is moved to the **Up** position, the vacuum interrupter will close.

Understanding the LED Indicators and POSITION Indicator

LED Indicators

There are two white LEDs on the base of the VacuFuse II interrupter. See Figure 4.

The CHARGING LED indicates the VacuFuse II interrupter is harvesting energy to close the vacuum interrupter. When the VacuFuse II interrupter is powered, the CHARGING LED will start flashing at one flash per second as long as sufficient voltage is present at the cutout mounting and the vacuum interrupter is open. When full charge is achieved, the READY TO CLOSE LED will solidly illuminate, and the CHARGING LED will keep flashing.

NOTICE

At least 4 amperes of primary current must be flowing through the VacuFuse II Self-Resetting Interrupter to power the control from its **Sleep** state. When powered, the control will remain powered if the current through the device does not fall below 4 amperes. If less than 4 amperes of primary current is present, the VacuFuse II Self-Resetting Interrupter will still respond properly to fault current.

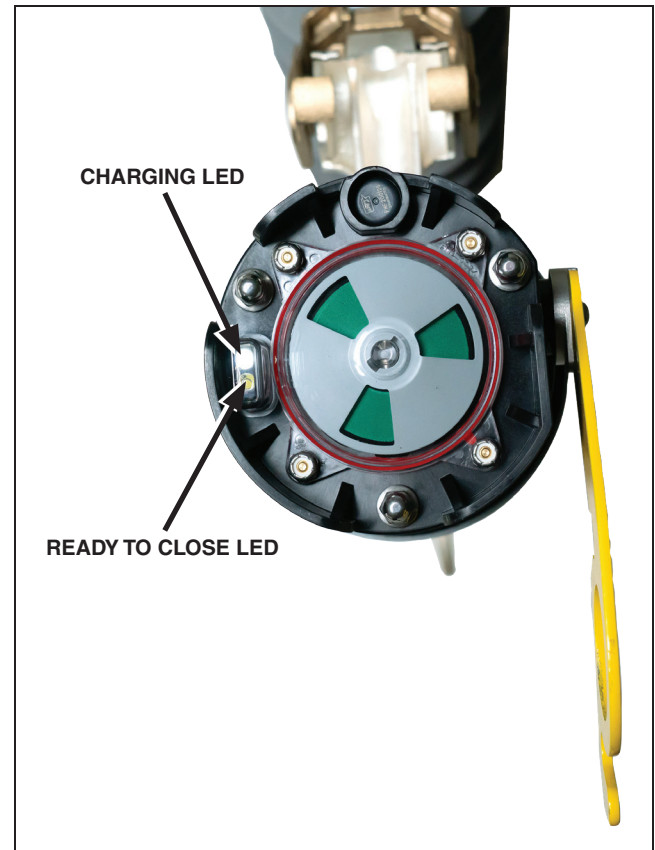

Figure 4. The LEDs on the base of the VacuFuse II interrupter.

Before Starting

POSITION Indicator

The POSITION indicator is located on the base of the VacuFuse II interrupter's housing. It contains a highly reflective visible red or green target that indicates the position of the vacuum interrupter inside the VacuFuse II Self-Resetting Interrupter. The target is green when the vacuum interrupter is in the **Open** position and red when the vacuum interrupter is in the **Closed** position. See Figure 5 and Figure 6.

NOTICE

Catalog number option “-J1” reverses the colors of the POSITION indicator to red for the **Open** position and green for the **Closed** position. This option is available to utilities that require reversed colors on their system.

Do not refer to the position of the manual operating lever to know the position of the vacuum interrupter. When the VacuFuse II interrupter trips in response to a fault, the lever does not move, leaving the lever in the **Up** position when the vacuum interrupter is in the **Open** position. Always observe the POSITION indicator to know the position of the VacuFuse II interrupter's vacuum interrupter.

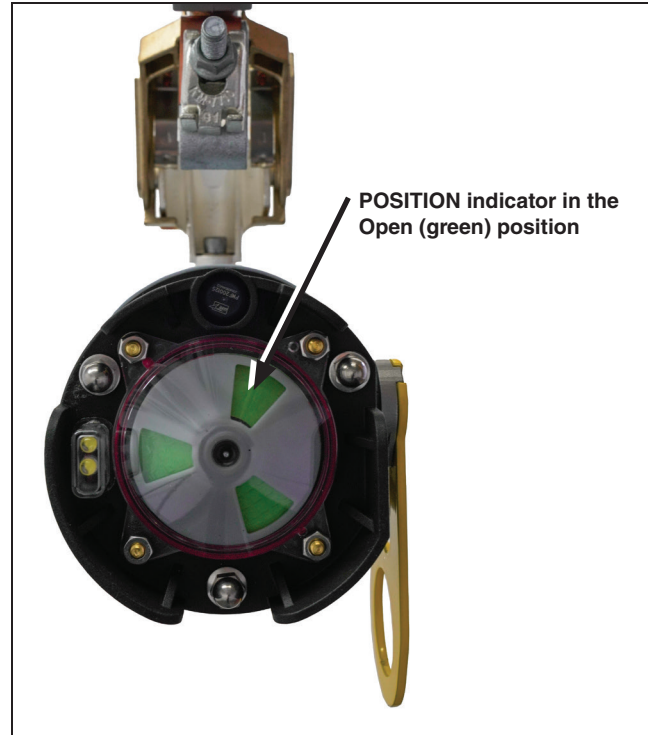

Figure 5. The vacuum interrupter in the Open position.

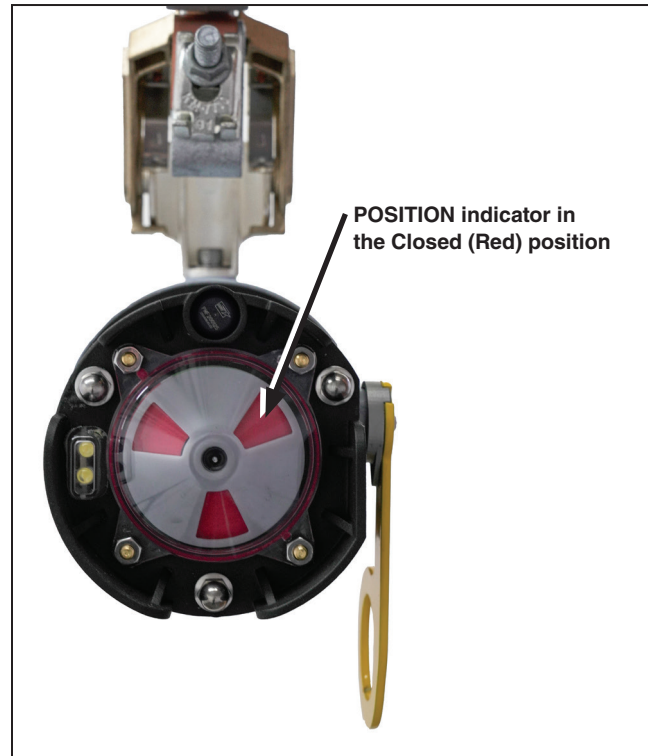

Figure 6. The vacuum interrupter in the Closed position.

Installing the Cutout Mounting

If a VacuFuse II interrupter is ordered without a cutout mounting, proceed to the “Installing a VacuFuse II Interrupter into the Cutout Mounting” section on page 14.

Complete the following steps to install the cutout mounting for the VacuFuse II Self-Resetting Interrupter:

- STEP 1.** Attach the VacuFuse II interrupter cutout mounting to a suitable mounting bracket, as illustrated in Figure 7. Tighten the carriage bolt nut until snug but loose enough to permit pivot adjustment. Note the placement of the external-tooth lockwasher between the mounting bracket and the center insert of the mounting.

Note: A mounting bracket suitable for crossarm, pole, or wall mounting is furnished only if specified through the addition of suffix “-B” or “-C” to the VacuFuse II interrupter catalog number.

- STEP 2.** Pivot the mounting to a position that will provide maximum ease of operation and then securely tighten the carriage-bolt nut.
- STEP 3.** Make electrical connections. When using aluminum conductors, be sure to wire-brush them and apply a coating of oxidation inhibitor before inserting them into the mounting’s connectors.

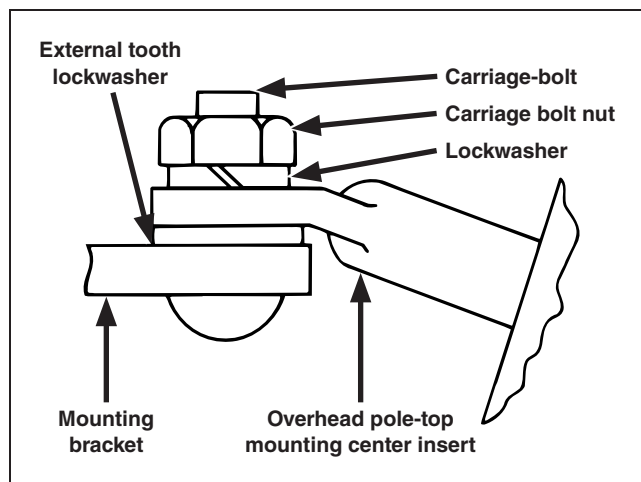

Figure 7. Attaching an overhead pole-top style VacuFuse II interrupter cutout mounting to the mounting bracket.

Installation

Installing a VacuFuse II Interrupter into the Cutout Mounting

WARNING

Provide training to line crews on the use of both a hotstick and an extendostick before installing or operating the VacuFuse II Self-Resetting Interrupter. The VacuFuse II interrupter is different from other cutout-mounted devices. Failure to properly handle a VacuFuse II interrupter with a hotstick and/or an extendostick may lead to serious injury or death.

Complete the following steps to install a VacuFuse II interrupter into a cutout mounting:

STEP 1. *If using an existing S&C cutout mounting or other approved cutout mounting:*

Visually inspect the cutout mounting for damage or excessive wear, particularly in the upper and lower contact areas. If ANY damage is visible, replace the cutout mounting before proceeding. DO NOT install and/or energize a VacuFuse II Self-Resetting Interrupter into a damaged cutout mounting.

STEP 2. *Installation Using Insulated Gloves:*

With the manual operating lever in the **Down** position, insert the VacuFuse II Self-Resetting Interrupter into a 110-kV BIL or a 125/150-kV BIL-rated mounting with gloved hands, as shown in Figure 8.

STEP 3. *Installation using the Talon™ Handling Tool:*

Attach a Talon Handling Tool to a short hotstick. Insert the curled prong of the Talon tool into the lifting eye of the trunnion, and raise the VacuFuse II interrupter into the mounting. Rotate the hotstick counterclockwise 180 degrees to disengage it. See Figure 9.

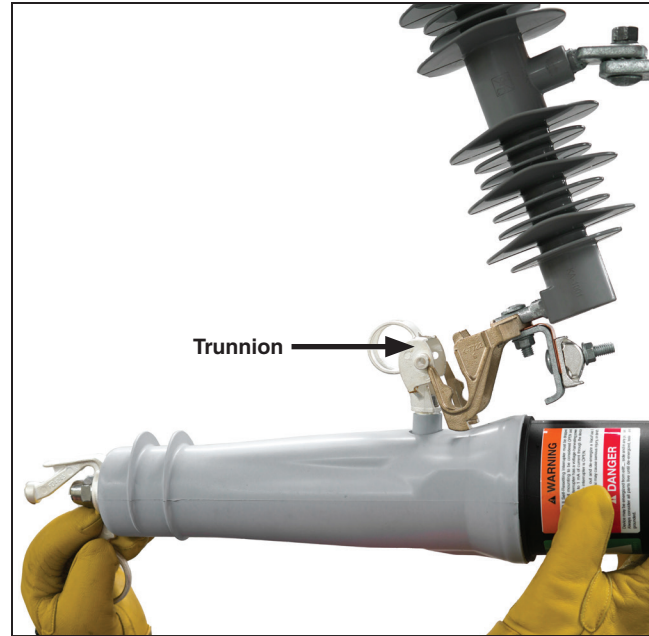

Figure 8. Guiding the trunnion into the hinge of the cutout mounting using gloved hands.



Figure 9. Using a Talon tool during installation.

Closing the VacuFuse II Interrupter into the Cutout Mounting

Complete the following steps to close a VacuFuse II Self-Resetting Interrupter into its mounting:

NOTICE

Read the “Understanding the Closing Sequence” section on page 10 before closing the VacuFuse II Self-Resetting Interrupter into its cutout mounting.

- STEP 1.** Confirm the VacuFuse II Self-Resetting Interrupter is in the **Open** position by viewing its POSITION indicator. See the “Understanding the LED Indicators and POSITION indicator” section on page 11 for more information. Place the manual operating lever in the correct position for the closing sequence desired. See the “Understanding the Closing Sequence” section on page 10.
- STEP 2.** Stand firmly in front of and in line with the cutout mounting. Do not operate standing directly underneath the VacuFuse II Self-Resetting Interrupter. If using an extendostick, stand from 6 to 10 feet (1.8 to 3 m) away from the pole.
- STEP 3.** Insert the straight prong of a Talon Handling Tool or a distribution prong into the pull-ring.
- STEP 4.** Swing the VacuFuse II interrupter to within approximately 45 degrees of the fully **Closed** position, as shown in Figure 10.
- STEP 5.** While firmly gripping the stick, drive the VacuFuse II interrupter closed with forward force. Maintain the forward force until the interrupter properly closes and latches into the cutout mounting.
- STEP 6.** Disengage the prong from the pull-ring, taking care to avoid pulling the VacuFuse II interrupter open.

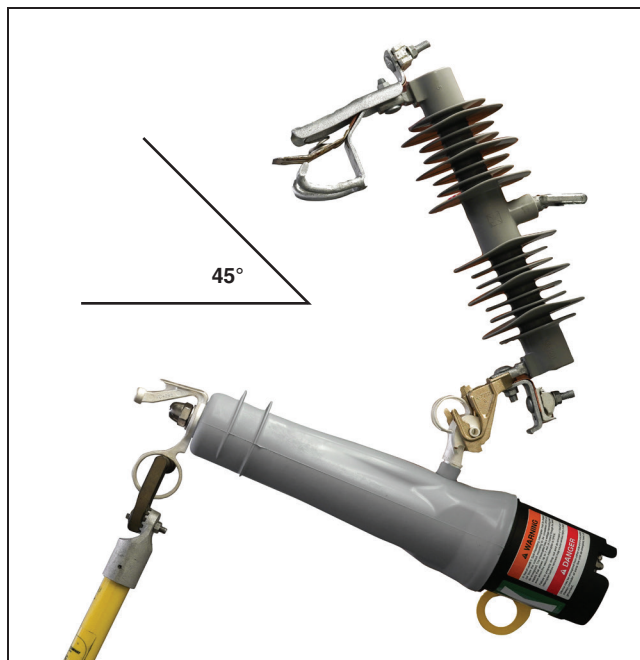

Figure 10. A VacuFuse II interrupter within approximately 45 degrees of the fully Closed position.

If the VacuFuse II Self-Resetting Interrupter Has Dropped Open

 **WARNING**

The VacuFuse II Self-Resetting Interrupter is designed to protect distribution transformers from internal and external fault current. A VacuFuse II Self-Resetting Interrupter found in the **Open and Drop Out** position should not be closed until the cause of the fault current has been determined and repaired. Closing without repairing the fault could result in equipment damage, injury, or death.

After responding to an overcurrent event, the VacuFuse II interrupter's vacuum interrupter will open and the POSITION indicator will show a green target. If the overcurrent event persists after the fault-testing event, the unit will lock out and drop out from the cutout mounting.

Note: Non-fault-testing VacuFuse II interrupters will lock out and drop out from the cutout mounting every time the device responds to an overcurrent event.

Follow these steps if the VacuFuse II Self-Resetting Interrupter has operated and is in the **Open and Drop Out** position:

- STEP 1.** Remove the VacuFuse II Self-Resetting Interrupter from its mounting, if required by utility practice, following the steps in the "Removing the VacuFuse II Interrupter from the Cutout Mounting" section starting on page 20.
- STEP 2.** Determine and resolve the cause of the fault.
- STEP 3.** After the cause of the fault has been determined and after any necessary repairs have been completed, install the VacuFuse II Self-Resetting Interrupter and close it into the mounting following the steps described in the "Installation" section starting on page 13.

If Maintenance Is to Be Performed on the Transformer

Follow these steps if maintenance is to be performed on the transformer:

- STEP 1.** Open the vacuum interrupter inside the VacuFuse II Self-Resetting Interrupter by moving the manual operating lever to the **Down** position firmly using the straight prong of the Talon tool or a distribution prong. See Figure 11.
- STEP 2.** After the VacuFuse II Self-Resetting Interrupter opens and drops out (after approximately 1 minute and 45 seconds), remove the unit from its mounting, if required by utility practice. Follow the steps in the “Removing the VacuFuse II Interrupter from the Cutout Mounting” section starting on page 20. This creates a visible “open gap” showing the transformer is isolated from the feeder. Depending on your utility’s standard practices, additional grounds may be required.
- STEP 3.** Follow your utility’s standard practice for performing transformer maintenance. After any necessary maintenance or repairs have been completed, install the VacuFuse II Self-Resetting Interrupter and close it into the mounting following the steps described in the “Installation” section starting on page 13.



Figure 11. The manual operating lever in the Up position.

Opening and Closing the VacuFuse II Interrupter

WARNING

The VacuFuse II Self-Resetting Interrupter is designed to protect distribution transformers from internal and external fault current. A VacuFuse II interrupter found in the Open and Drop Out position (POSITION indicator displaying a green target) should NOT be closed until the cause of the trip operation has been determined and repaired. **Closing without repairing the fault could result in equipment damage, injury, or death.**

The vacuum interrupter inside the VacuFuse II Self-Resetting Interrupter can be opened using the yellow manual operating lever on the side of the VacuFuse II interrupter, with or without power. The interrupter must be closed in the cutout mounting with sufficient voltage present for at least 45 seconds before the vacuum interrupter can be closed by moving the lever to the **Closed** position.

The VacuFuse II Self-Resetting Interrupter will “drop out” of the cutout mounting after one minute when the vacuum interrupter is in the **Open** position and the **READY TO CLOSE LED** is lit.

To Open: Pull the yellow manual operating lever down firmly using the straight prong of the Talon tool or a distribution prong. Remove the tool right away. The vacuum interrupter inside the VacuFuse II interrupter will open, and the POSITION indicator will show the green target. After one minute and 45 seconds of the vacuum interrupter in the **Open** position, the unit will drop out. See Figure 12.

To Close: Push the pull-ring of the yellow manual operating lever up firmly using the straight prong of the Talon tool or a distribution prong. The vacuum interrupter inside the VacuFuse II interrupter will close after 45 seconds of sufficient voltage being present at the cutout mounting, and the POSITION indicator will show the red target. See Figure 13. If the VacuFuse II interrupter is inadvertently closed into a fault, the vacuum interrupter will trip open independently of any force still applied to the manual operating lever.

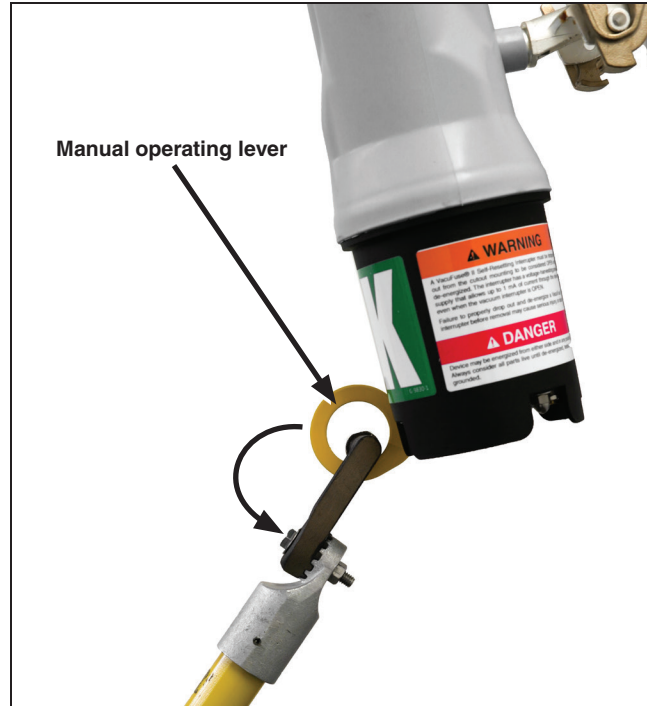

Figure 12. Operating the manual operating lever into the Down position.



Figure 13. Operating the manual operating lever into the Up position.

To Reset the Manual Operating Lever After Manually Closing into Fault Current: When the VacuFuse II interrupter trips in response to a fault, the lever does not move, leaving the lever in the **Up** position when the vacuum interrupter is open. The lever can be “reset” by operating it to the **Down** position while the vacuum interrupter is open. When the lever is in the **Up** position, the interrupter will automatically close the next time it is pushed into the cutout mounting.

Note: After the interrupter drops open (either because of a permanent fault or moving the manual operating lever to the **Down** position and waiting for the unit to drop open), it is necessary to wait at least 20 seconds before closing the interrupter into the cutout mounting again. If the interrupter is closed into the cutout mounting immediately after a permanent fault, it will drop-out without closing. This happens because of the interrupter interpreting that it never dropped-out from the cutout mounting.

Removing the VacuFuse II Interrupter from the Cutout Mounting

WARNING

DO NOT attempt to remove a VacuFuse II Self-Resetting Interrupter from its cutout mounting with the vacuum interrupter in the **Closed** position. The vacuum interrupter is in the **Closed** position when the POSITION indicator at the base of the VacuFuse II interrupter displays a red target. Removing the VacuFuse II interrupter from its cutout mounting with the vacuum interrupter in the **Closed** position may cause arcing, equipment damage, serious injury, or death.

Complete the following steps to remove the VacuFuse II interrupter from its cutout mounting:

STEP 1. Open the vacuum interrupter inside the VacuFuse II interrupter by pulling down on the yellow manual operating lever. Confirm the POSITION indicator at the base of the VacuFuse II interrupter displays a green target.

STEP 2. Wait one minute and 45 seconds until the VacuFuse II Self-Resetting Interrupter drops out.

If the VacuFuse II Self-Resetting Interrupter stays in its cutout mounting, confirm the POSITION indicator at the base of the VacuFuse II interrupter displays a green target. Use the troubleshooting guide on page 26 to determine the cause of the problem and the appropriate action to take.

STEP 3. *Removal Using Gloved Hands:* Remove the VacuFuse II Self-Resetting Interrupter from its cutout mounting with gloved hands, as shown in Figure 14.

STEP 4. *Removal Using the Talon Handling Tool:* Attach a Talon Handling Tool to a short hotstick. Insert the curled prong of the Talon tool into the lifting eye of the trunnion, and raise the VacuFuse II interrupter out of the mounting. See Figure 9 on page 14.



Figure 14. Removing the VacuFuse II interrupter with gloved hands.

Operation Using Loadbuster®— The S&C Loadbreak Tool

If the VacuFuse II Self-Resetting Interrupter is in its cutout mounting with the vacuum interrupter in the **Closed** position and operating the manual operating lever to the **Open** position does not work, or the VacuFuse II interrupter is to be removed from its cutout mounting in the **Closed** position for any other reason, it may be safely removed using S&C's Loadbuster tool. Following an opening operation with the Loadbuster tool, the VacuFuse II interrupter can be lifted out of the mounting with gloved hands.

WARNING

DO NOT attempt to open a VacuFuse II Self-Resetting Interrupter that is in the **Closed** position without using a loadbreak tool such as S&C's Loadbuster tool. An arc started by opening a VacuFuse II Self-Resetting Interrupter under load without a loadbreak tool can cause equipment damage, serious injury, or death.

WARNING

DO NOT attempt to use a Loadbuster tool to open a VacuFuse II Self-Resetting Interrupter while climbing the pole. Engagement of a Loadbuster tool in this position is difficult and may result in improper opening operation, leading to arcing, faults, equipment damage, serious injury, or death.

WARNING

Stay at least 5 feet (152 cm) below the VacuFuse II interrupter when operating the Loadbuster tool from a bucket truck. Operating the Loadbuster tool from less than 5 feet away is difficult and may result in an improper opening operation, leading to arcing, faults, equipment damage, serious injury, or death.

Operation

Follow these steps when using S&C's Loadbuster tool:

- STEP 1.** Check for proper resetting of the Loadbuster tool by extending the tool about 3 inches (76 mm) by hand. Throughout this travel, an increasing spring resistance should be felt.
- STEP 2.** Fasten the Loadbuster tool to an S&C Universal Pole not less than 6 feet (183 cm) long (8 feet [244 cm] for catalog number 5400R3) with the frame of the tool in line with the pole. As shown in Figure 15 and Figure 16, the Loadbuster tool must be attached so it reaches across the front of the VacuFuse II Self-Resetting Interrupter, and the Loadbuster tool's anchor must be hooked to the attachment hook on the far side of the VacuFuse II interrupter.



Figure 15. A correct fastening approach.



Figure 16. A correct fastening approach.

The Loadbuster tool should never be attached with its anchor hooked on the closest side of the VacuFuse II interrupter, as shown in Figure 17 and Figure 18. Attaching the tool in this manner will not only obscure the operator's line of vision, but it could also result in bending stress on the tool, causing improper disengagement.



Figure 17. An incorrect approach.



Figure 18. An incorrect approach.

Operation

STEP 3. Swing the Loadbuster tool toward the VacuFuse II Self-Resetting Interrupter and pass the Loadbuster pull-ring hook through the pull-ring on the VacuFuse II Self-Resetting Interrupter. The pull-ring latch will deflect and, upon complete entry of the pull-ring, will spring back, locking the Loadbuster tool to the pull-ring. The Loadbuster tool is now connected across the upper contacts of the VacuFuse II Self-Resetting Interrupter, as shown in Figure 19.

STEP 4. To open the circuit, operate the Loadbuster tool with a firm, steady pull until it is extended to its maximum length. A downward pull to open the VacuFuse II Self-Resetting Interrupter extends the Loadbuster tool and charges the tool's internal spring. At a predetermined point in the opening stroke, a trigger inside the tool will trip, releasing the charged spring, separating the internal contacts and interrupting the circuit. See Figure 20.

Successful operation is independent of the speed with which the VacuFuse II Self-Resetting Interrupter is opened. Avoid jerking and hesitation. The resetting latch will keep it open. Generally, there is no indication of circuit interruption; the only sound is that of the Loadbuster tool tripping.

WARNING

Careless manipulation of the Loadbuster tool can decrease the open gap to the point where a flashover could occur. **This can result in arcing, electrical shock, serious injury, or death.**

STEP 5. To detach the Loadbuster tool after circuit interruption, first raise it slightly and disengage the anchor from the attachment hook.

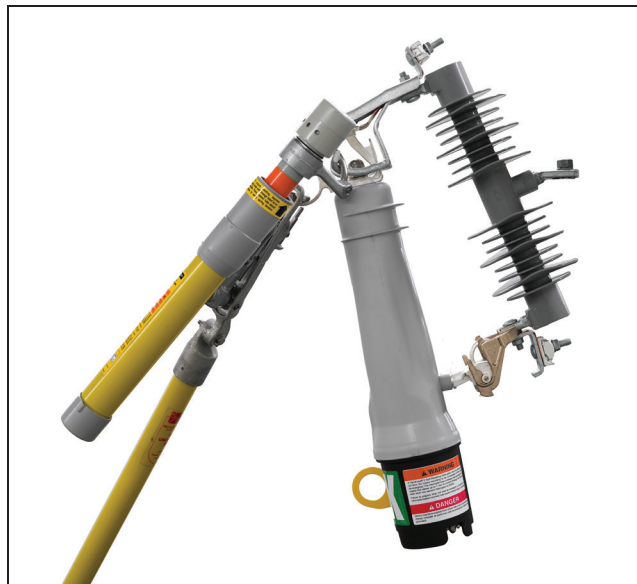

Figure 19. The loadbuster tool attached to a VacuFuse II Self-Resetting Interrupter in the Closed position.

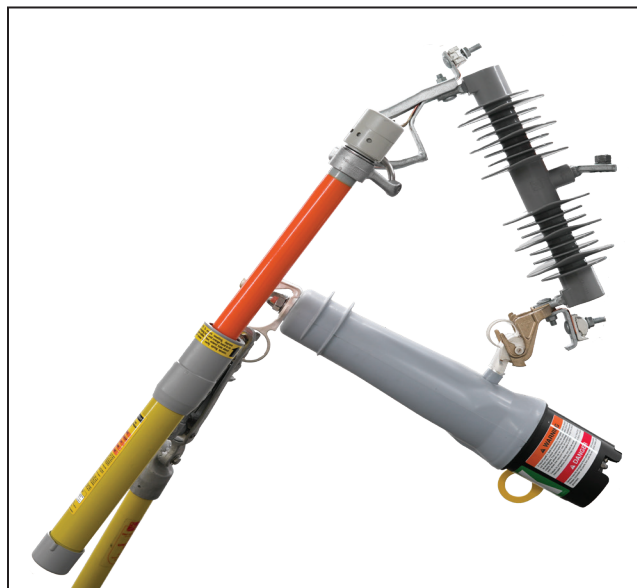

Figure 20. The Loadbuster tool attached to a VacuFuse II Self-Resetting Interrupter in the Open position.

STEP 6. Bring the VacuFuse II Self-Resetting Interrupter toward the **Drop Out** position. Then, remove the Loadbuster tool from the pull-ring by rotating the pole. This will deflect the pull-ring latch to release the pull-ring. Because the VacuFuse II Self-Resetting Interrupter will drop fully open from gravity, it may be preferable to remove the Loadbuster tool by “rolling” it off both the attachment hook and pull-ring at the same time by twisting the pole after the Loadbuster tool has been tripped and fully extended. To perform this operation smoothly, always roll the Loadbuster tool so that it rotates in an upward direction.

STEP 7. To reset the Loadbuster tool for the next operation, hold it as shown in Figure 21. Extend the tool slightly and lift the resetting latch with your thumb. With the latch up, telescope the tool completely so the trigger can reset itself. Depress the telescoping tube until the orange paint on the inner tube assembly is no longer visible. Check for proper resetting by extending the tool about 3 inches (76 mm). Throughout this travel, an increasing spring resistance should be felt.

Note: When the VacuFuse II Self-Resetting Interrupter is opened with a Loadbuster tool, the vacuum interrupter inside the VacuFuse II interrupter will not be triggered open and will remain closed.



Figure 21. Resetting the Loadbuster tool.

Unable to Close a VacuFuse II Interrupter into its Mounting

If a VacuFuse II interrupter's vacuum interrupter is in the **Open** position, the unit is dropped out, and it cannot be successfully closed into the cutout mounting, then the VacuFuse II interrupter has reached its **End-of-Life** state. Remove the unit from its cutout mounting and return it to S&C Electric Company for service.

In Mounting With Contacts Open

There are three scenarios in which a VacuFuse II interrupter may remain in its cutout mounting with the vacuum interrupter open:

1. The VacuFuse II interrupter does not have sufficient voltage present in the cutout mounting to charge and drop out. In this case, return of voltage to the cutout mounting should cause the CHARGING LED to blink, and the unit will drop open after approximately 45 seconds.
2. The VacuFuse II interrupter is stuck in the cutout mounting and is powered. In this case, with sufficient voltage the CHARGING LED will continue to blink. The VacuFuse II interrupter will repeatedly attempt to drop out while voltage is present. If it does not successfully drop out within 3 hours, the unit will go into its **End-of-Life** state.

To prevent premature end of life, use Loadbuster®—The S&C Loadbreak Tool to operate the VacuFuse II interrupter into the **Dropout** position. Refer to the “Operation Using Loadbuster®—The S&C Loadbreak Tool” section on page 21.

3. The VacuFuse II interrupter is stuck in the cutout mounting and is in **Abnormal** mode. In this case, check for voltage in the cutout mounting.

If sufficient voltage is present in the cutout mounting and the CHARGING LED is not blinking, the unit is in **Abnormal** mode. Remove the VacuFuse II interrupter from the cutout mounting following the steps in the “Operation Using Loadbuster®—The S&C Loadbreak Tool” section on page 21. Then, return the unit to S&C Electric Company for service.

If there is insufficient voltage in the cutout mounting, wait for power to be restored to the cutout mounting. Then, test for the three scenarios described above.

Vacuum Interrupter Cannot Be Closed

If the VacuFuse II interrupter can be closed into the cutout mounting and sufficient voltage is present in the mounting—but the vacuum interrupter cannot be closed through either of the two closing methods described in the “Understanding the Closing Sequence” section on page 10—then the VacuFuse II interrupter is in **Abnormal** mode. After removing the unit from the cutout mounting, return it to S&C Electric Company for service.